

折蝕刻片的指示綫:

Bend the PE part along the line To bend forward To bend backward

Wire number 配綫編號: **1**

注意這些零件與車殼的配合! Pay attention to the fitting of small parts and cowling

將車頭改成圖中狀態
Modify the shape as the figure shown

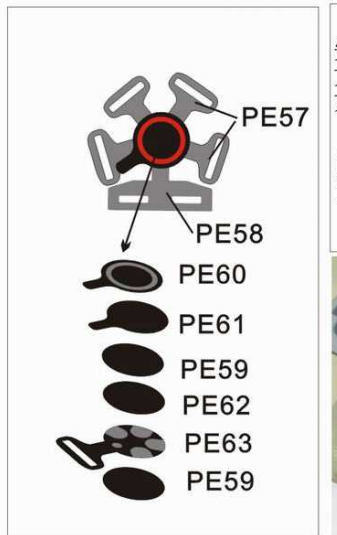
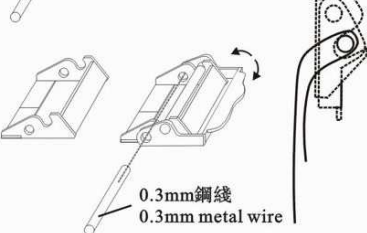
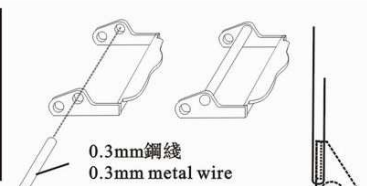
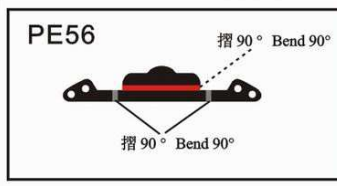
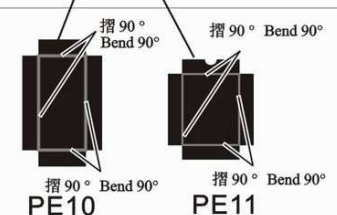
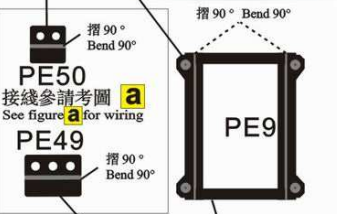
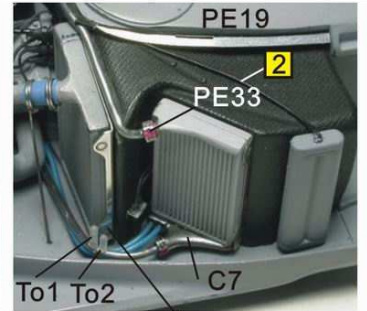
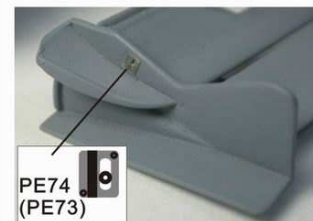
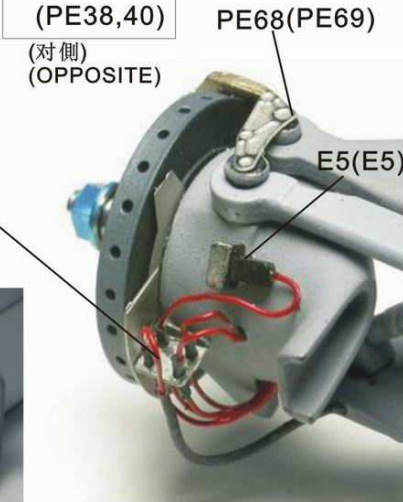
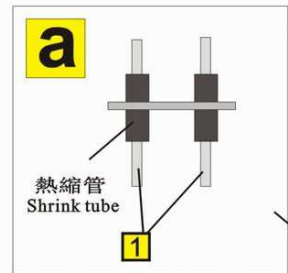
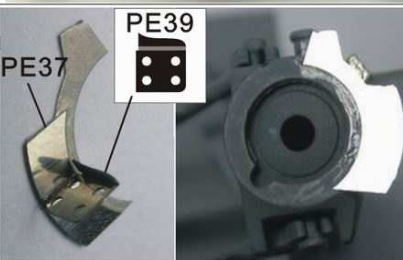
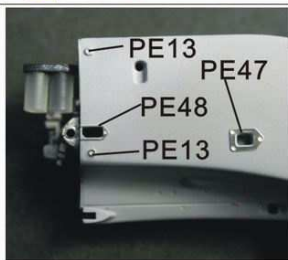
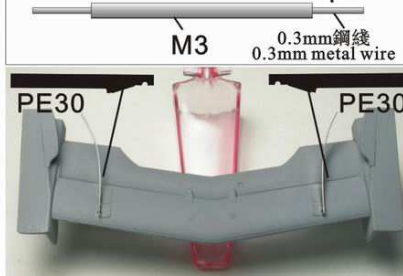
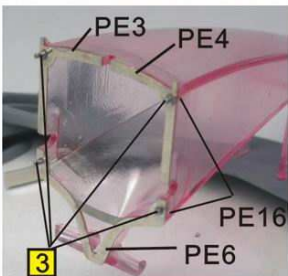
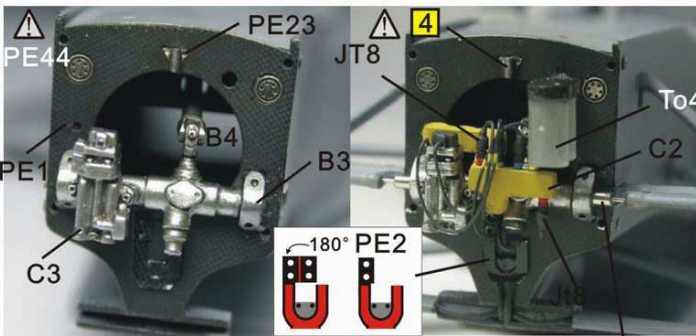
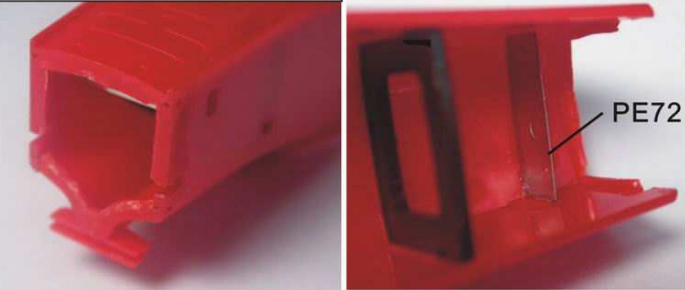

安全帶制作:
方法1:直接使用紅色絲帶.
方法2:將白布噴成紅色,再用鋒利的筆刀裁成布條使用

Seat belt making:
Method 1: Use the red ribbon as seat belt directly
Method 2: Paint the white cloth with red, then cut it into a stripe by a sharp hobby knife



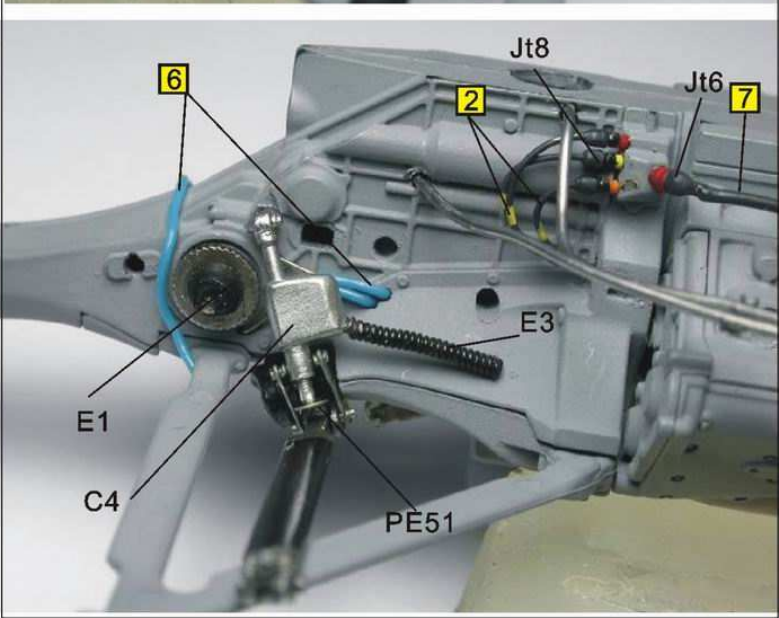
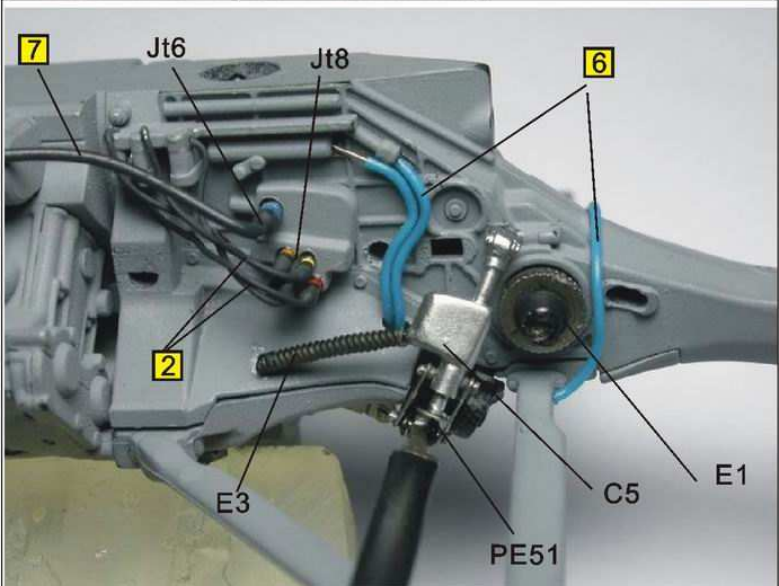
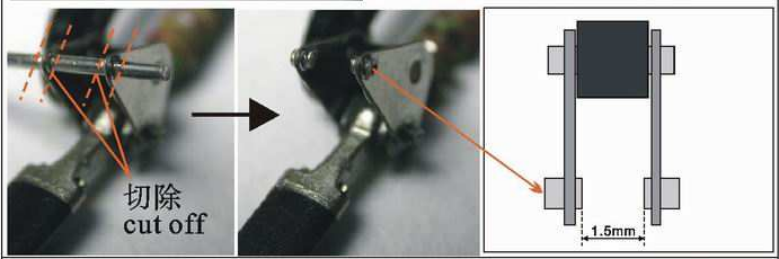
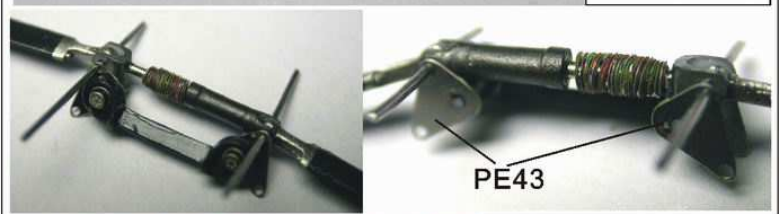
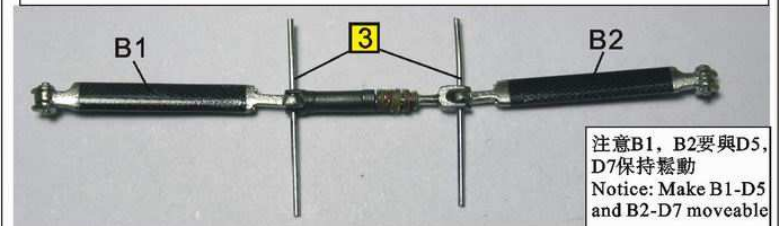
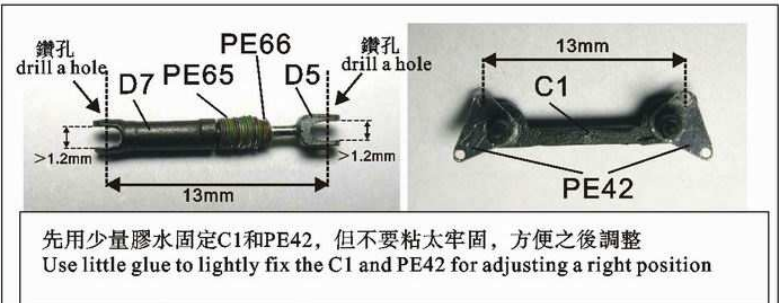
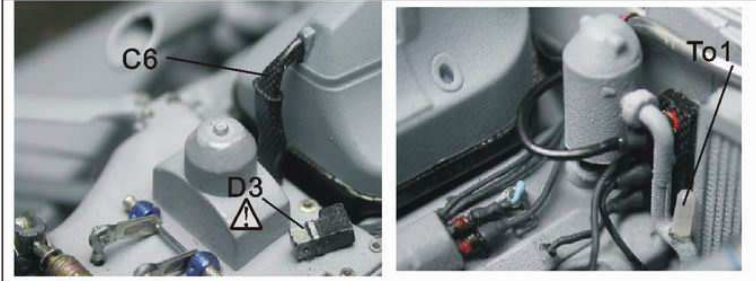
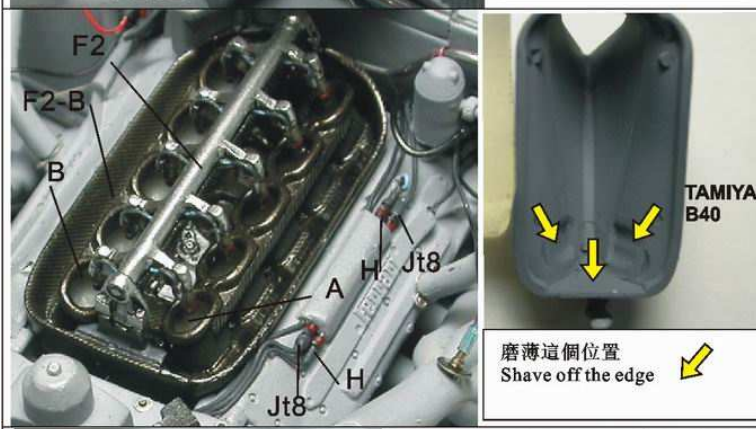
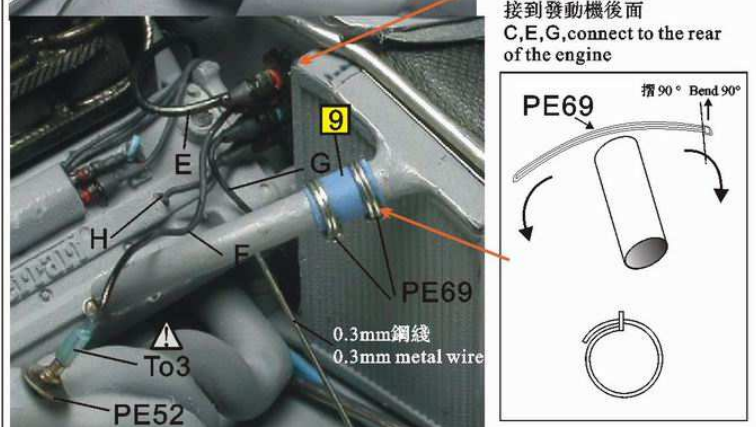
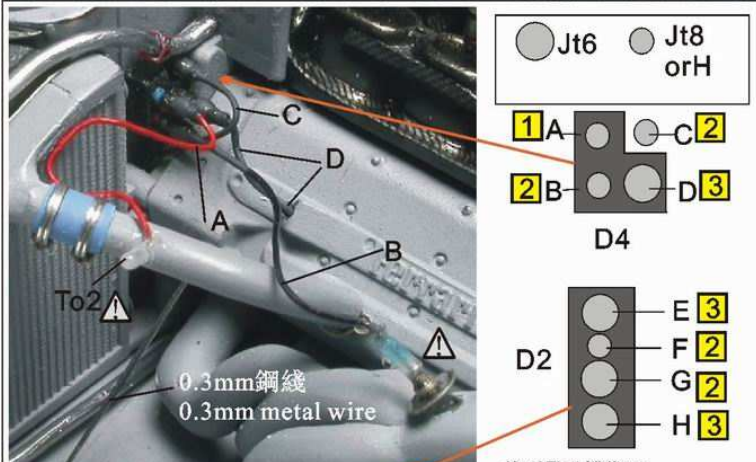
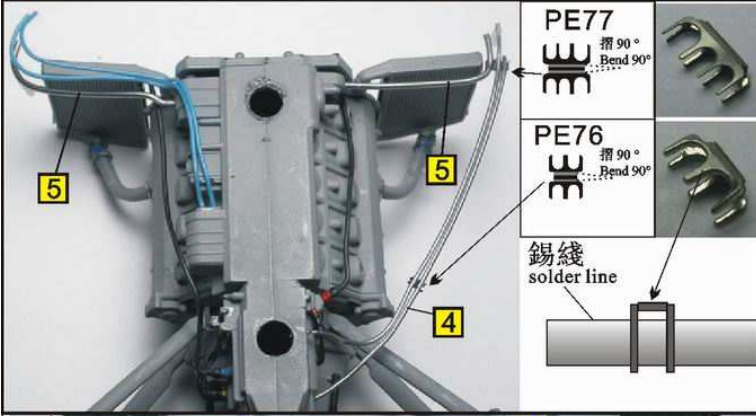

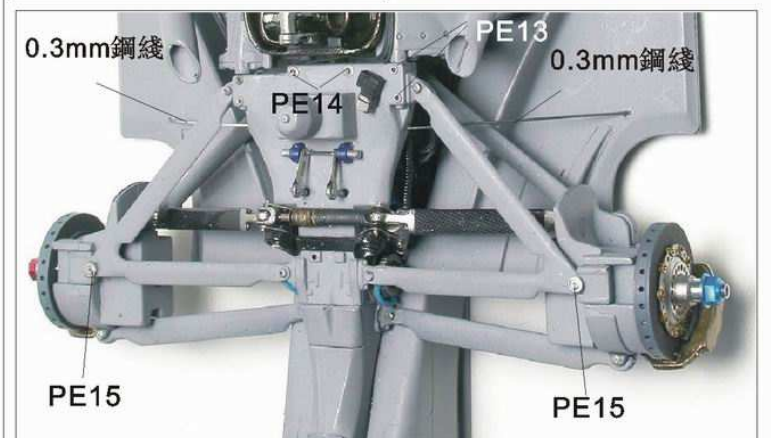
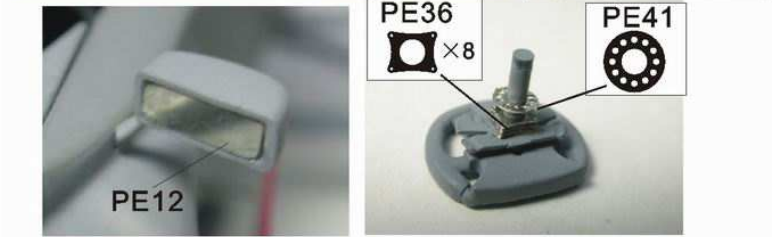
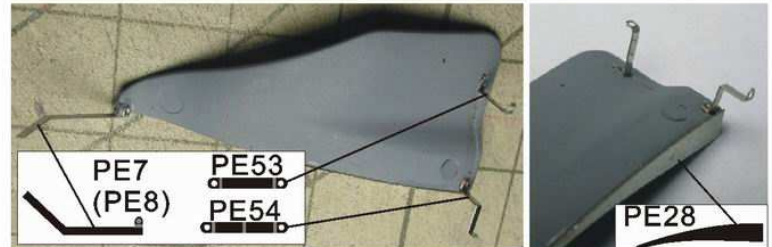
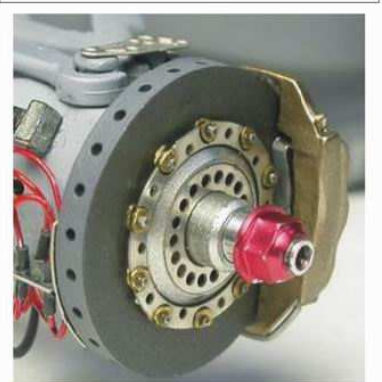
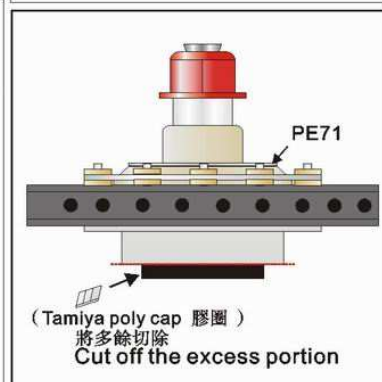
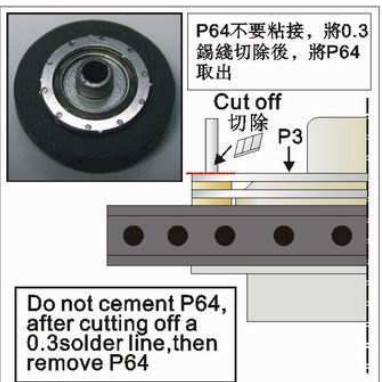
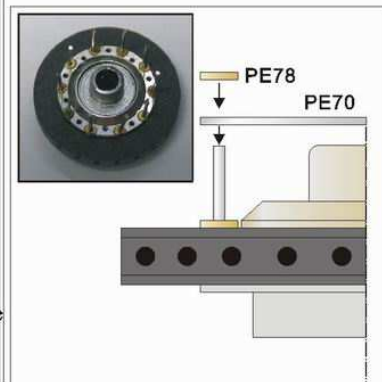
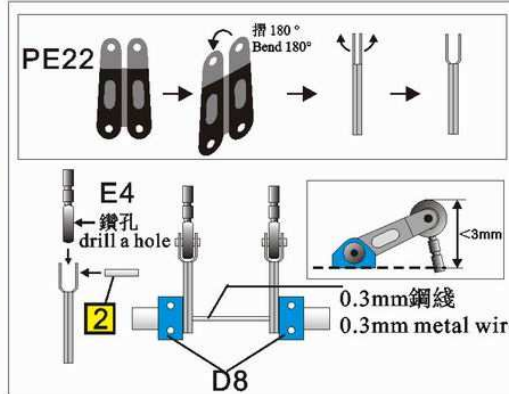
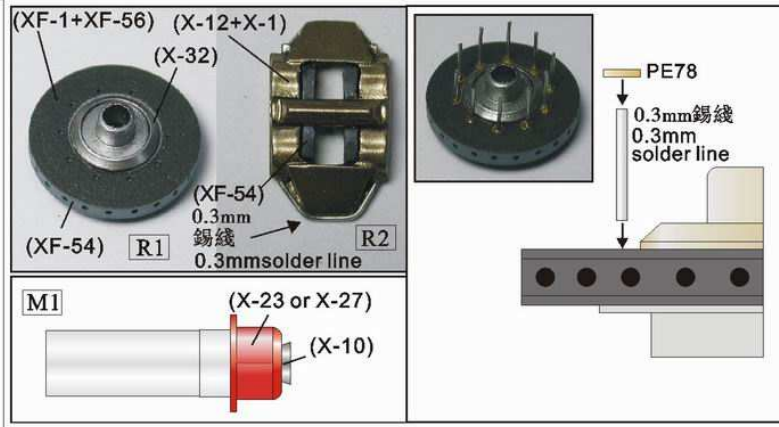

編號 number	規格 specification	數量 Quantity
1	0.2mm 金屬線 0.2mm metal wire	×1
2	0.3mm 錫線 0.3mm solder line	×1
3	0.5mm 錫線 0.5mm solder line	×1
4	0.6mm 錫線 0.6mm solder line	×1
5	0.8mm 錫線 0.8mm solder line	×1
6	藍色電線 blue wire	×1
7	黑色電線 black wire	×1
8	熱縮管 (黑) shrink tube(black)	×2
9	熱縮管 (藍) Shrink tube(blue)	×1

Using the shrink tube:
 熱縮管使用:
 1. 將熱縮管均勻加熱，加熱後，熱縮管收縮 (此時為收縮的最大直徑)
 1. heat the shrink tube evenly, it will be shrunk (the tube now in the largest diameter)

2. 待1~2秒後，將熱縮管拉長，可得到更小的線徑，拉伸越長，線徑越小。
 2. after 1~2 seconds, stretch the tube, it will be shrunk more when stretch more

加熱 Heat
 拉长 stretch

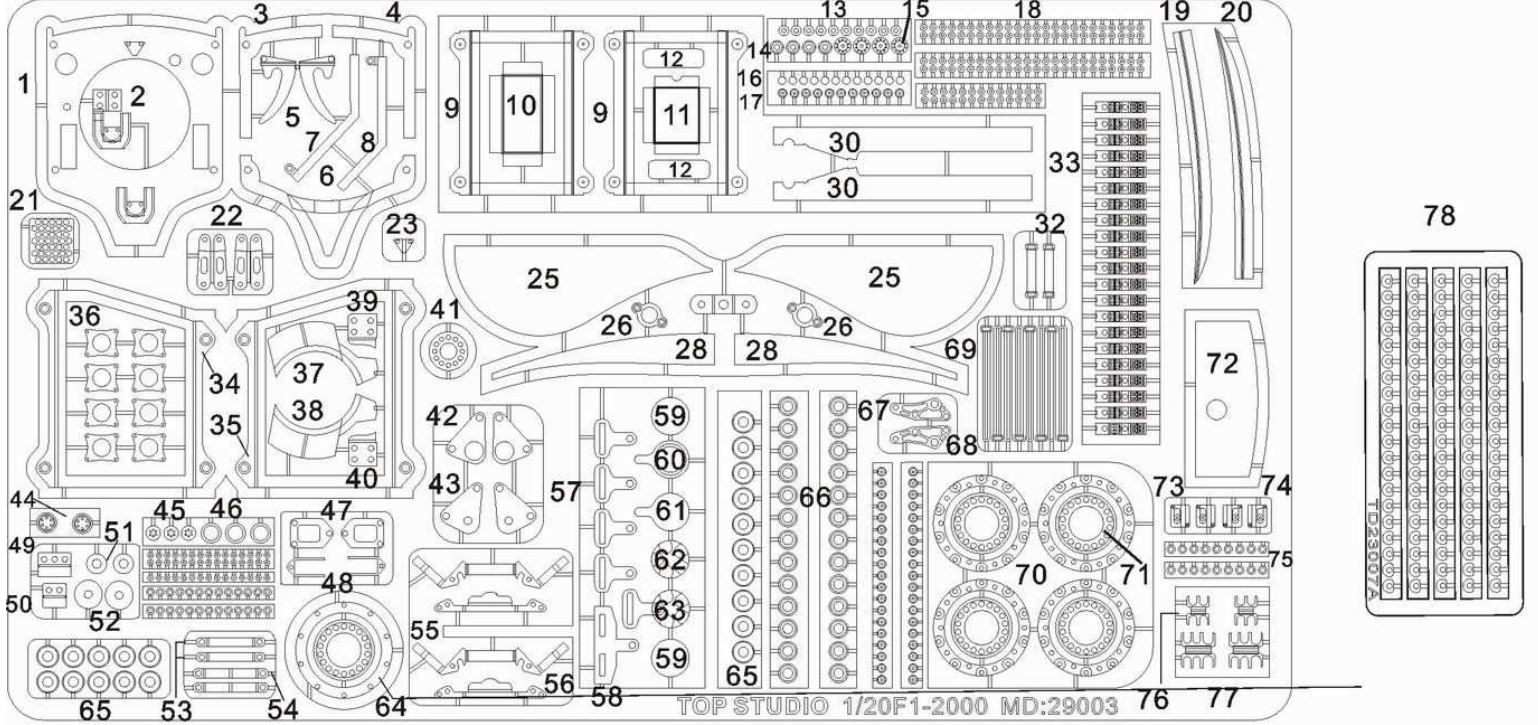

金屬部件
Metal Parts

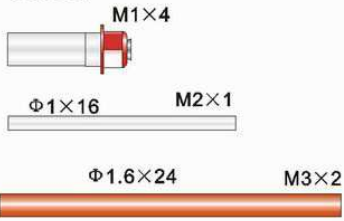

其它配件:
Other materials

- 0.3mm鋼線 ×1
0.3mm metal wire
- 紅色絲帶 ×1
red ribbon
- 白色布 ×1
white cloth
- 鋁箔貼紙 (用于制作隔熱層) ×2
metal foil sticker (using as heat shield)

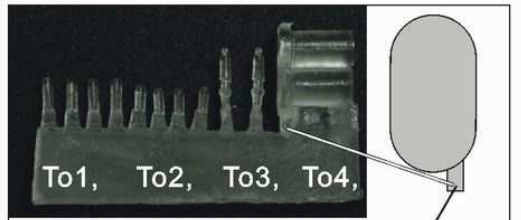

注意這根柱, 不要切除, 把它固定在PE1
Pay attention to this pole, don't cut it off.
Fix it over Pe1

樹脂部件
Resin Parts

